

Hydraulic Resistance of Vitreous Cutters: The Impact of Blade Design and Cut Rate

Tommaso Rossi¹, Giorgio Querzoli², Giampiero Angelini³, Carlo Malvasi³, Alessandro Rossi³, Mario Morini³, Graziana Esposito⁴, Alessandra Micera⁴, Natale Mario di Luca⁵, and Guido Ripandelli⁴

¹ IRCCS Azienda Ospedaliera Universitaria San Martino, IST Istituto Nazionale per la Ricerca sul Cancro, Genoa, Italy

² University of Cagliari, DICAAR, Cagliari, Italy

³ Optikon 2000 Inc., Rome, Italy

⁴ IRCCS - G.B. Bietti Foundation, Rome, Italy

⁵ University of Rome La Sapienza, Rome, Italy

Correspondence: Tommaso Rossi MD, Via Tina Modotti 93 - 00142 Rome, Italy. e-mail: tommaso.rossi@usa.net

Received: 1 October 2015

Accepted: 26 March 2016

Published: 1 July 2016

Keywords: cut rate; human vitreous hydraulic resistance; pars plana vitrectomy; volumetric flow rate; vitreous viscosity; vitreous cutter

Citation: Rossi T, Querzoli G, Angelina G, et al. Hydraulic resistance of vitreous cutters: the impact of blade design and cut rate. *Trans Vis Sci Tech.* 2016;5(4):1. doi: 1167/tvst.5.4.1

Purpose: To measure the hydraulic resistance (HR) of vitreous cutters equipped with a Regular guillotine Blade (RB) or double edge blade (DEB) at cut rates comprised between 0 and 12,000 cuts per minute (CPM) and compare it with vitreous fragment size. This was an in vitro experimental study; in vivo HR measure and vitreous sampling.

Methods: HR, defined as aspiration pressure/flow rate, was measured in balanced salt solution (BSS; Alcon, Fort Worth, TX) (in vitro) and during pars plana vitrectomy of 20 consecutive patients aged 18 to 65, undergoing macular surgery. HR was recorded at increasing cut rates (500–6000 CPM for the RB and 500–12,000 CPM for the DEB; 5 mL/min flow). Vitreous samples were withdrawn and analyzed with Western and collagen type II and IX immunostaining to evaluate protein size. The main outcome measures were hydraulic resistance (mm Hg/ml/min [\pm SD]) and optic density for Western blot and immunostaining.

Results: RB and DEB showed identical HR in BSS between 0 and 3000 CPM. Above 3000 CPM, RB HR steadily increased, and was significantly higher than DEB HR. Vitreous HR was also similar for the two blades between 0 and 1500 CPM. Above 1500 CPM, RB offered a significantly higher resistance. Western blot and immunostaining of vitreous samples did not yield a significant difference in size, regardless of blade type and cut rate.

Conclusions: DEB is more efficient, offering a lower HR than RB over 1500 CPM in human vitreous. There is no viscosity reduction as a function of cut-rate between 1500 and 12,000 CPM, as HR does not vary.

Translational Relevance: Future vitreous cutters will benefit of a DEB; optimal cut rate needs to be defined, and the simple increase of cut rate does not provide benefits after a certain limit to be assessed.

Introduction

Pars plana vitrectomy (PPV) is necessary and applicable to treat a multitude of vitreoretinal pathologic entities including retinal detachment, vitreomacular interface abnormalities, complications of diabetic retinopathy, and ocular trauma, to name a few.

Recently, microincisional, small gauge vitrectomy, has gained popularity due to the reduced invasiveness and operative times and more rapid patient recovery

and enhanced comfort.¹ To ensure an acceptable flow-rate of vitreous through smaller gauge instrumentation, aspiration pressures of vitreous cutters increased, and consequently, so did cut-rate, in an effort to mitigate vitreous pulling.^{2,3} Higher cut rates act to reduce traction by more rapidly severing the collagen fibers engaged within the aspiration port. Additionally, an increased cut rate has been associated with higher flow rates through the port,⁴ postulating that the creation of smaller vitreous

fragments determines a reduction in vitreous viscosity.⁵

The issue deserves further investigation and remains controversial, as is the use of dynamic viscosity to measure cutters efficiency. Vitreous flow through the cutter probe is a complex phenomenon depending on a number of factors. The vitreous cannot be assimilated to a homogeneous fluid when aspirated through small bores, due to the presence of solid macromolecules comparable to the instrument lumen. In addition, probe geometry and kinematics largely affect vitreous flow. In order to include in a single, comprehensive index the actual efficiency of the vitreous flow, we used hydraulic resistance (HR) defined as the ratio of the energy loss generated by the flow (which is compensated by the aspiration pump) to the flow rate. As such, HR is a cumulative measure of all factors contributing to energy dissipation along the probe and the aspiration circuit: viscosity, circuit geometry, collagen fibril size and shape, duty-cycle related port obstruction, and so on.

Herein, we report the HR of two different vitreous cutter blade designs, the Regular guillotine Blade (RB) and the Double Edge Blade⁶ (DEB; Twedge Blade; Optikon 2000 Inc., Rome, Italy), at cut rates between 0 and 12,000 cuts per minute (CPM). In addition, vitreous samples were collected and molecular analysis was performed to determine if an increasing cut rate corresponded to smaller vitreous collagen molecule fragments.

Materials and Methods

Vitreous Cutter Machine and Settings

All functions were performed using the integrated phacovitrectomy machine Optikon R-Evolution CS (Optikon 2000 Inc.) and 23-G probes mounting either a RB or a double edged, 100% duty cycle Twedge Blade,⁵ each of which use a pneumatic/spring mechanism of action. This newly introduced design (DEB) cuts on both the distal and proximal side of the port, leaving an invariant port surface open, thus achieving a 100% duty cycle (Fig. 1). The machine is equipped with a Venturi and peristaltic pump, but used only the latter, in order to ensure constant average volumetric flow rate (and therefore constant fluid velocity). The peristaltic pump was allowed to rotate until a steady state was reached and readings prior to this were disregarded.

Main Outcome Measures

HR was defined as the ratio of the vacuum generated by the aspiration peristaltic pump ($\Delta P =$ Pressure Delta), to the preset flow rate (Q) generated by the pump, (preset to $Q = 5$ mL/min unless otherwise specified); therefore, $HR = \Delta P/Q$ (HR was expressed in mm Hg/mL \times min \pm SD).

Theoretical vitreous chunk length (TVCL), defined as the length of the column of vitreous entering the port between two consecutive cuts, measured in microns (\pm SD), calculated assuming constant flow rate (and therefore fluid velocity):

$$TVCL = Q/(S \times CR) \quad (1)$$

Where Q = flow rate through aspiration line; S = cutter port surface; CR = cut rate.

The above formula holds under the assumption that the fluid column progresses with constant velocity through the cutter port, as imposed by the peristaltic pump. However, in previously investigations we demonstrated that, even if the flow rate averaged over a large number of cut cycles is nearly constant, the instantaneous flow rate varies according to blade motion. We named this “plunger effect,”¹ a phenomenon capable of generating an instantaneous flow of 40 to 50 mL/min (i.e., 10-fold the average flow). In an effort to account for this flow fluctuation and describe chunk length variability range, we computed the TVCL corresponding to the minimum, average, and maximum flow-rate, respectively.

In Vitro Measures

In vitro HR measures were performed with the vitreous cutter shaft immersed in a small receptacle filled with balanced salt solution (BSS) (Alcon, Fort Worth, TX). The pressure necessary to reach and maintain the peristaltic pump in a steady state at the desired flow (5 mL/min) was recorded. Twenty consecutive measurements for each cut rate were performed and HR was computed as the ratio of pressure to flow rate. Mean \pm SD is reported.

In Vivo Measures

The present study followed the tenets of the Declaration of Helsinki and received institutional review board approval.

Similar to in vitro measurements, HR of human vitreous was computed by recording pressure at given cut rates after reaching the steady state of the peristaltic pump at a preset flow rate (5 mL/min). In all cases, pressure measurements were taken with the

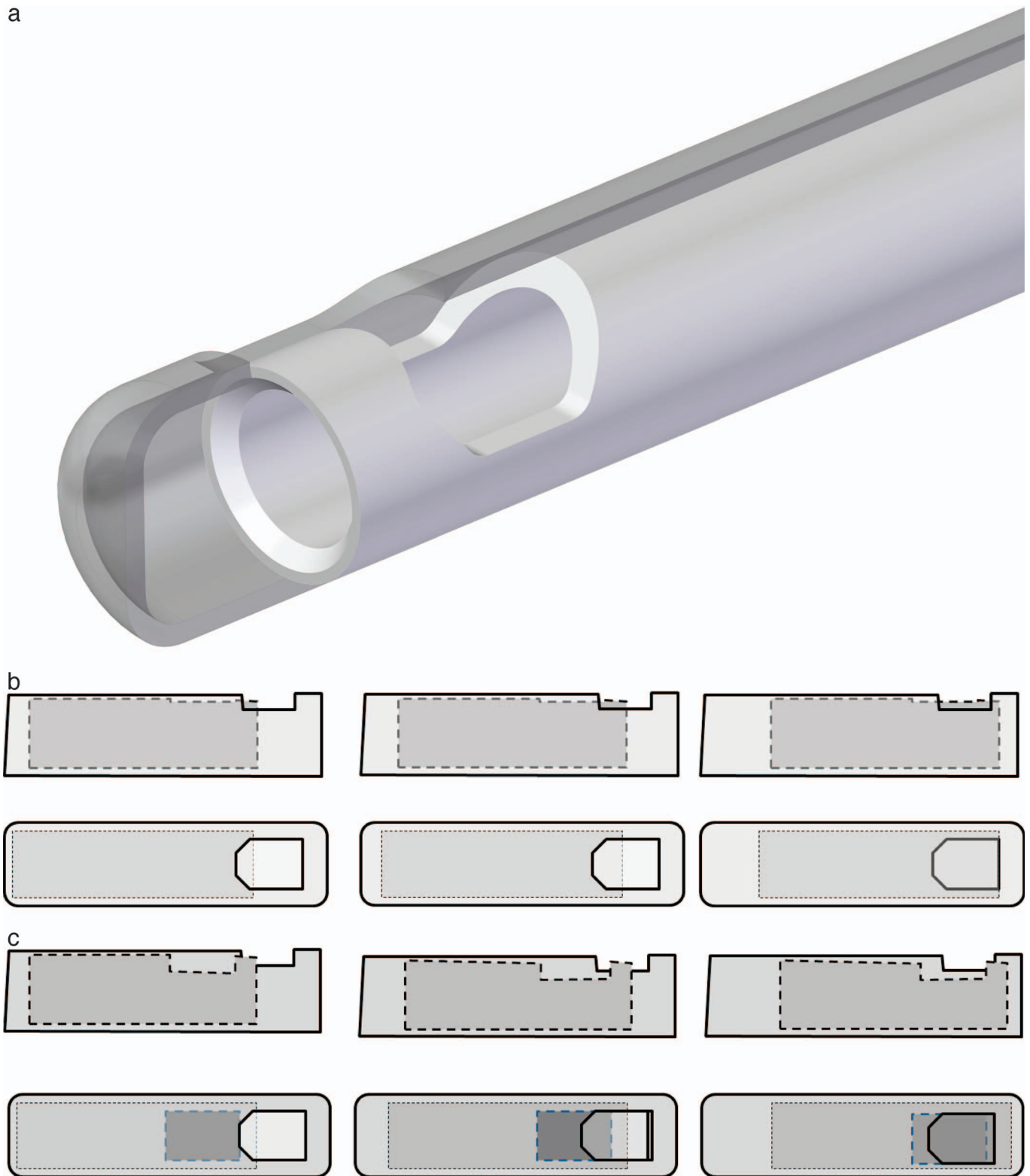

Figure 1. (a) Three-dimensional rendering of the DEB showing the inner cylinder blade design that allows an invariant opening of the cutter port and double cutting action at the distal and proximal edge of it. Blade motion occurs along the cutter shaft longer axis and is actuated through pneumatic/spring motion. (b) Schematic drawing of RB port showing the three phases of cutting cycle: open (*left hand side image*), closing (*middle image*), and closed port (*right image*). (c) Schematic drawing of the newly developed DEB port showing the same three phases of cutting cycle: note how the specific blade design prevents aspirating port closure throughout the duty cycle.

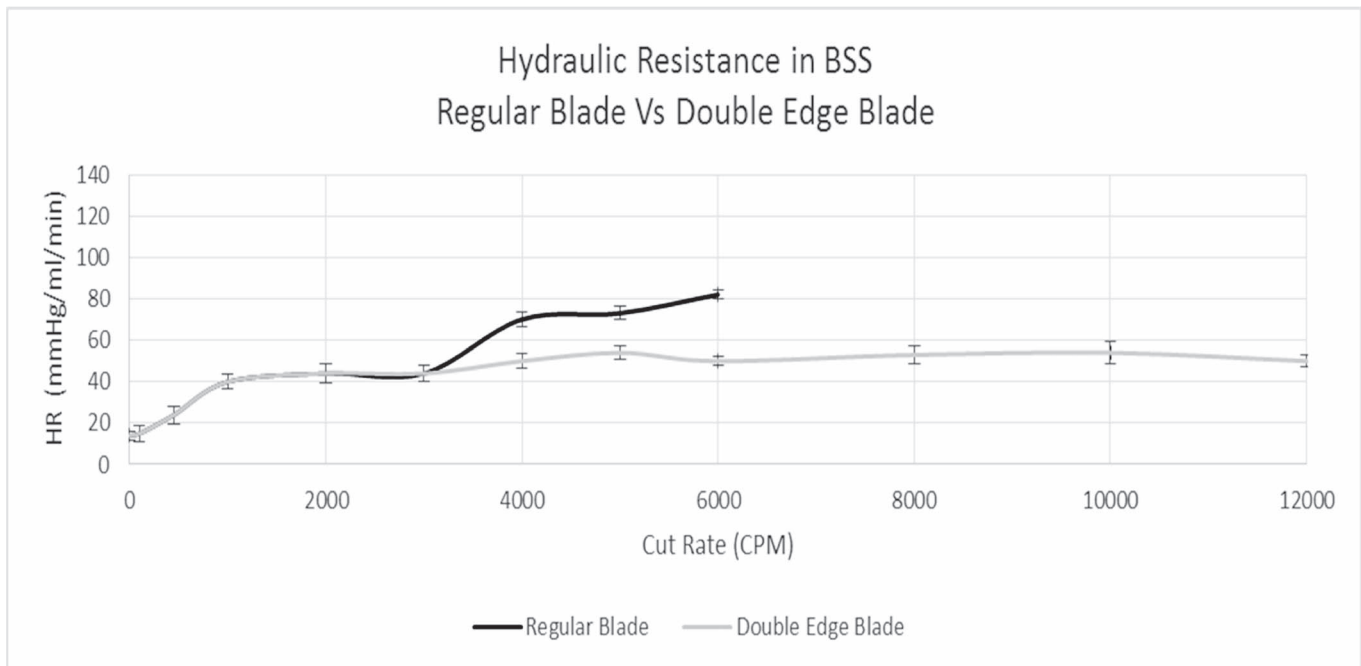

Figure 2. HR as a function of cut rate in BSS. RB (black line) is compared with DEB (gray line). Error bars indicate SD. Note that the RB cannot operate faster than 6000 CPM. HR reaches its minimum at 0 CPM. There is no significant difference in HR between 0 and 3000 CPM. Over 3000 CPM, RB HR is significantly greater than DEB.

cutter in the midvitreous at the onset of PPV. In all, 20 patients undergoing primary PPV for macular surgery with no identifiable vitreous pathology, aged 50 to 65, were included, and five separate measurements were taken for each identifiable cut rate. Aphakic eyes, and those eyes with any sign of vitreous pathology, were excluded.

Biochemical Analysis

Vitreous Sampling. There was 0.2 to 0.4 mL of vitreous obtained from 12 eyes for in vivo HR measurements (6 from RB and 6 from DEB). A given cut rate was set prior to starting vitrectomy and the vitreous was collected from the tubing attached to the probe at the very beginning of surgery to limit BSS dilution. Samples were frozen. For each blade design (RB and DEB, respectively), samples were collected at 1000, 2000, 3000, 4000, 5000, and 6000 CPM. Of note, unlike RB, the DEB cuts twice per each cutting cycle due to its double bevel design. Therefore, the DEB actual cut rate is twice the number of cutting cycles, and samples taken at 1000 through 6000 CPM refer to 2000 through 12,000 CPM (that cannot be reached by the RB). Due to this, the graphs in Figures 2 and 3 show unequal length of RB and DEB curves.

Vitreous samples underwent Western blot analysis to measure overall protein content, and immunoblotting with collagen type II and IX antibodies to discern the size of collagen fragments representing the backbone of the vitreous fibril structure.⁷

Statistical Analysis

Hydraulic Resistance Data. Two-tailed *t*-test compared RB and DEB HR measurements in BSS and vitreous. All descriptive data analysis and differences intra/intergroups were carried using SPSS software (version 15.0 for Windows; IBM, Chicago, IL). Data are shown as the mean (\pm SD) and differences were considered statistically significant at *P* less than 0.05.

Vitreous Samples Data. To establish the normal distribution of collagen data, repeated measures analysis of variance of optic density (OD) were undertaken on the group of collagen data. To test the influence of cut rate on collagen amounts, correlation studies used Spearman's rho test.

The percent coefficient of variation (% CV) for total protein amount was calculated for each measurement site as follows: $\% CV = (SD/mean) \times 100$. *P* values less than 0.05 have been considered significant.

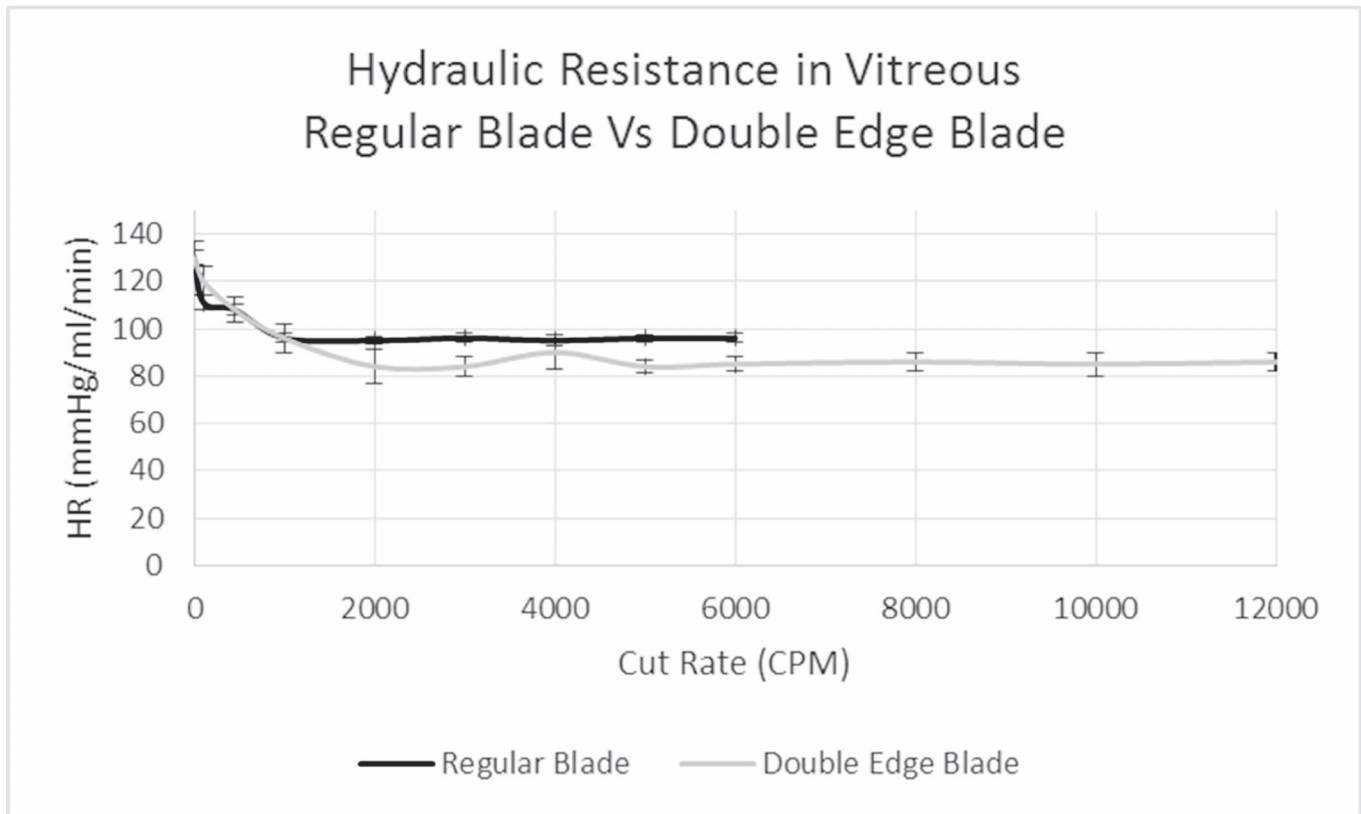

Figure 3. HR as a function of cut rate in vitreous. RB (black line) is compared with DEB (gray line). Error bars indicate SD. Note that the RB cannot operate faster than 6000 CPM. Contrary to Figure 2, HR peaks at 0 CPM because vitreous collagen fibers obstruct the cutter lumen. There is no significant difference in HR between 0 and 1000 CPM. Over 2000 CPM, RB HR is significantly greater than DEB although they both tend to plateau as cut rate increases further.

Results

Hydraulic Resistance

HR of RB and DEB as a function of cut rate (CPM), in BSS is reported in Figure 2. Both blades show a steep HR rise between 0 and 1000 CPM, reaching a plateau between 1000 and 3000 CPM. There is no statistically significant difference between 0 and 3000 CPM. For cut rates higher than 3000, DEB HR remains unchanged, while RB HR increases significantly, compared with both RB at lower cut rates and DEB at comparable cut rates ($P < 0.001$ in all cases).

Vitreous HR is shown in Figure 3. Between 0 and 1000 CPM, maximum suction was required to achieve desired flow (5 mL/min) and the two blades behaved similarly. Over 2000 CPM, DEB HR was significantly lower than RB HR ($P < 0.001$ at all points except at 4000 CPM where no difference could be detected).

Figure 4 shows the comparison of aspiration pressure needed to reach preset flow (5 mL/min) in

BSS versus vitreous for both blades (RB in Fig. 4a and DEB in Fig. 4b).

Theoretical Vitreous Chunk Length

Figure 5 reports the TVCL as a function of cut rate at typical flow rates achieved during vitrectomy as the flow rate ranges from 3 to 7 mL/min. Fragment size decreases steeply between 250 (2.78 μm at 5 mL/min) and 2000 CPM (0.35 μm at 5 mL/min). Over 2000 CPM and up to 12,000 CPM (0.06 μm at 5 mL/min), TVCL decreases very subtly.

Figure 6 reports the range of TVCL values due to instantaneous flow rate fluctuations, as previously described. The variability introduced by instantaneous flow fluctuation (dashed line shows TVCL at peak flow fluctuation) is over 10-fold the chunk length computed using average flow (continuous line). As a result, actual vitreous chunk length may result anywhere below the Q_{max} curve in Figure 6. For instance between 0 and 36.7 μm at 250 CPM, 0 and 4.7 μm at 2000 CPM and 0 and 1.5 μm at 6000 CPM.

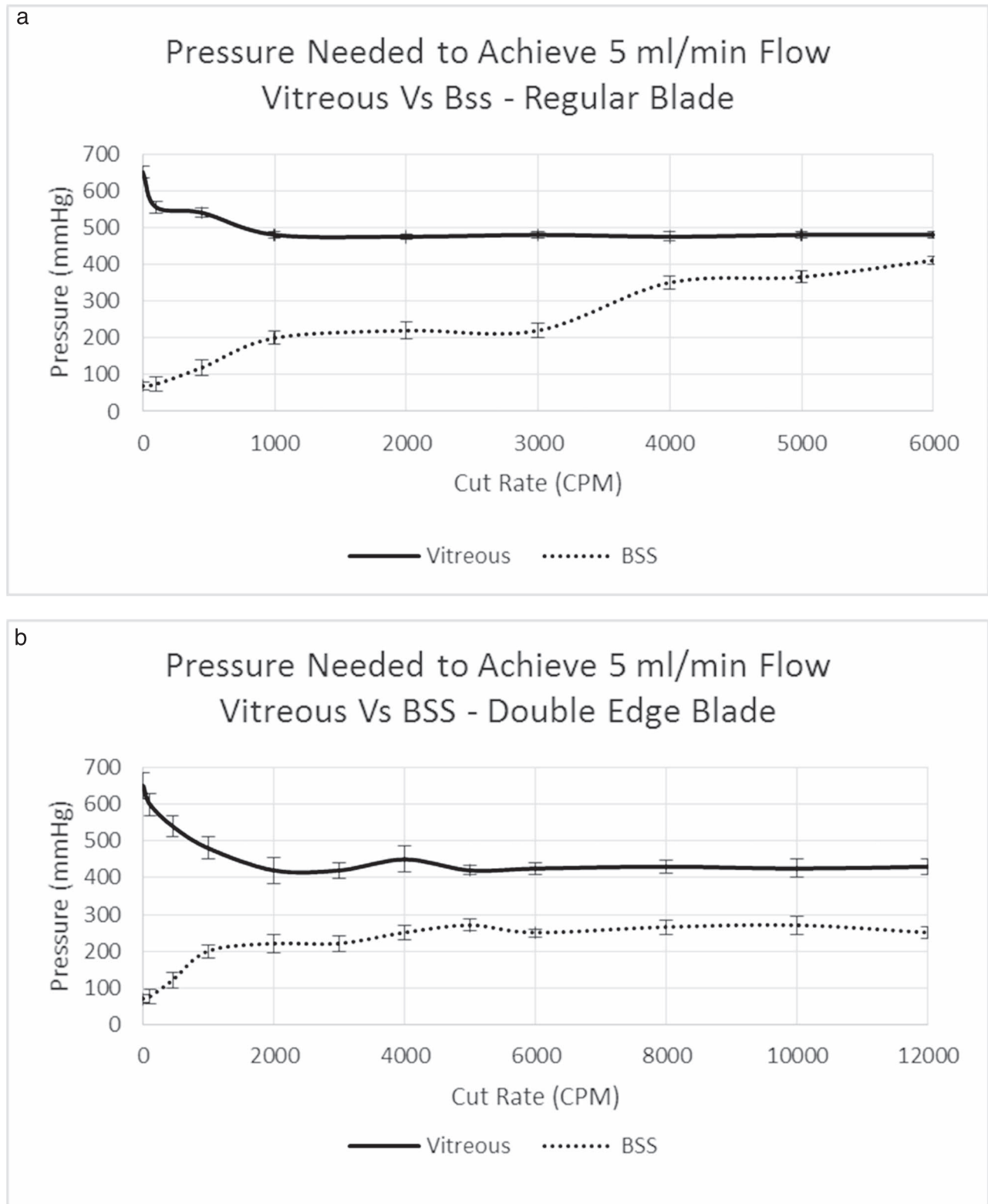

Figure 4. Pressure reached by the peristaltic pump to achieve a steady 5 mL/min flow in BSS and vitreous for the (a) RB and (b) DEB. Note that HR shown in Figures 2 and 3 is pressure divided by flow ($HR = P/F$). Therefore, the data presented in Figures 2 and 3 are presented here in a different manner. This graph highlights the pressure needed to achieve a given flow through the instruments' lumen. In both (a) and (b) it is apparent that pressure is invariant to cut rate over 2000 CPM. It is also important to note that given the maximum theoretical negative pressure obtainable is roughly 650 mm Hg (atmospheric pressure is 760 mm Hg), there is little room for flow increase by elevating pressure.

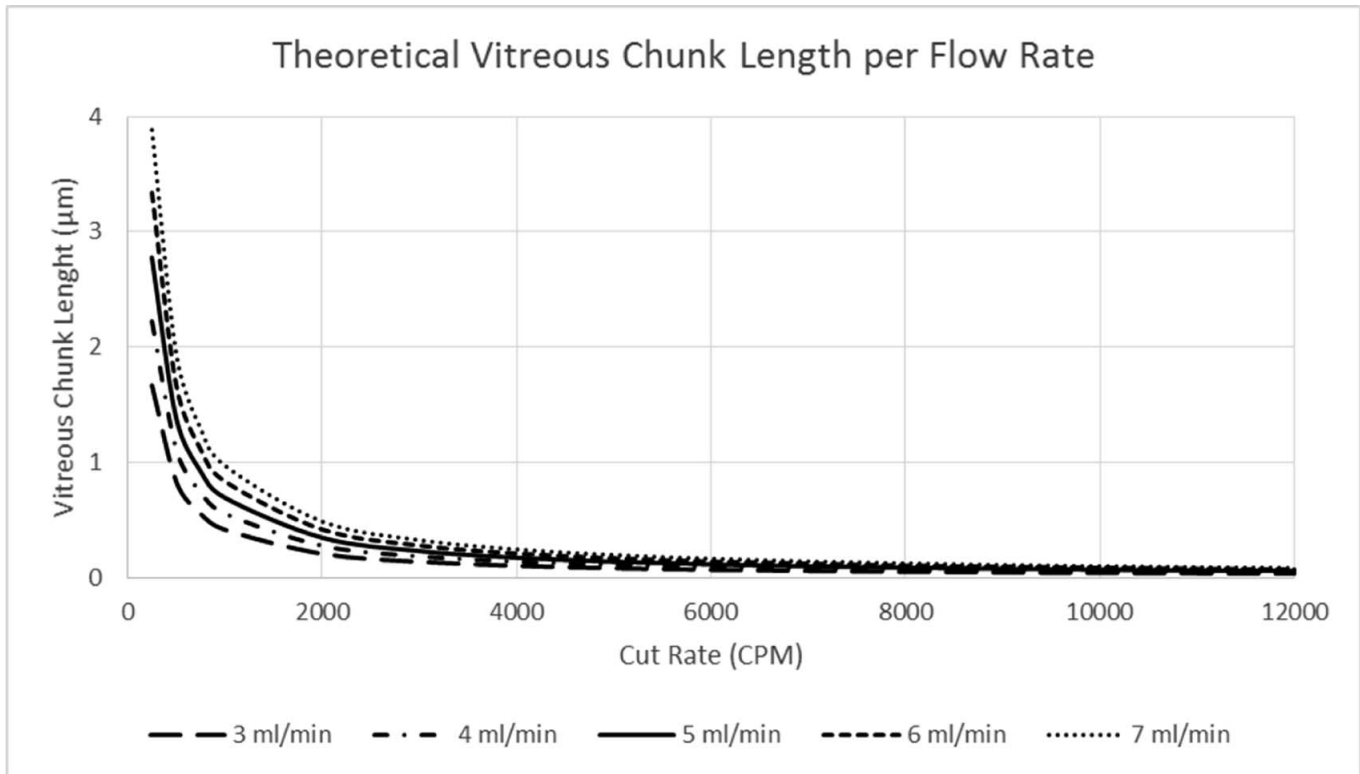

Figure 5. Theoretical vitreous chunk length (TVCL) as a function of cut rate, calculated on average flow rates comprised between 3 and 7 ml/min. Note that vitreous fragment length reduces less than 1/10 between 250 and 2000 CPM and almost insignificantly over 4000 CPM. Also note that different flow rates yield very similar results.

Vitreous Samples Electrophoresis and Immunoblot Analysis

All protein samples were quantified (1.52 ± 0.74 μL ; % CV = 48.32), normalized (30 $\mu\text{g}/\text{lane}$), and separated on a 10% (coll IX) and 7% (coll II) SDS-PAGE. Representative protein sketches are shown in Figure 7. There was no difference between RB and DEB protein sketches, regardless of cut rate. Increasing cut rate did not yield protein fragments of different molecular weight. The specific immunoblotting for collagen type II (190 KDa) and type IX (65 KDa) expression in both RB and DEB samples at selected 1000, 3000, and 6000 CPM does not show any significant difference among cut rates and/or blade type (Fig. 8).

Discussion

As instrumentation for vitrectomy has improved, the enthusiasm and acceptance for smaller gauge vitreous surgery has magnified. The luminal diameter of current vitreous cutters have narrowed significantly from Mocher's 18-G VISC⁸ to today's 27-G

designs. As such, functional changes were necessary. Aspiration pressure rose to counteract flow reduction (Table) and cut rate rose to reduce vitreous pulling⁹ generated by the higher pressures.¹⁰ However, intraocular fluidics in response to these changes may not have been entirely understood. Megalhaes and colleagues³ described a much less expected effect related to higher cut rates: an increase in vitreous flow rate. In their explanation, they proposed that smaller collagen fragments improved flow rate by reducing vitreous viscosity.

In order to investigate cut rate related viscosity changes, we measured the HR of two different blade designs: the RB and the recently introduced DEB^{1,2} (Fig. 1). HR encompasses all phenomena affecting vitreous aspiration: viscosity, collagen fibrils resistance, circuit geometry, and duty-cycle related port obstruction. Unlike vitreous viscosity, whose measure is often erratic due to gel decay and inconsistent methodology,¹¹⁻¹³ HR can be accurately measured under operative conditions. Additionally, due to the composition of the vitreous, basically a slurry of solid molecules interspersed in fluid, assuming its behavior consistently follows Newtonian rheological equations

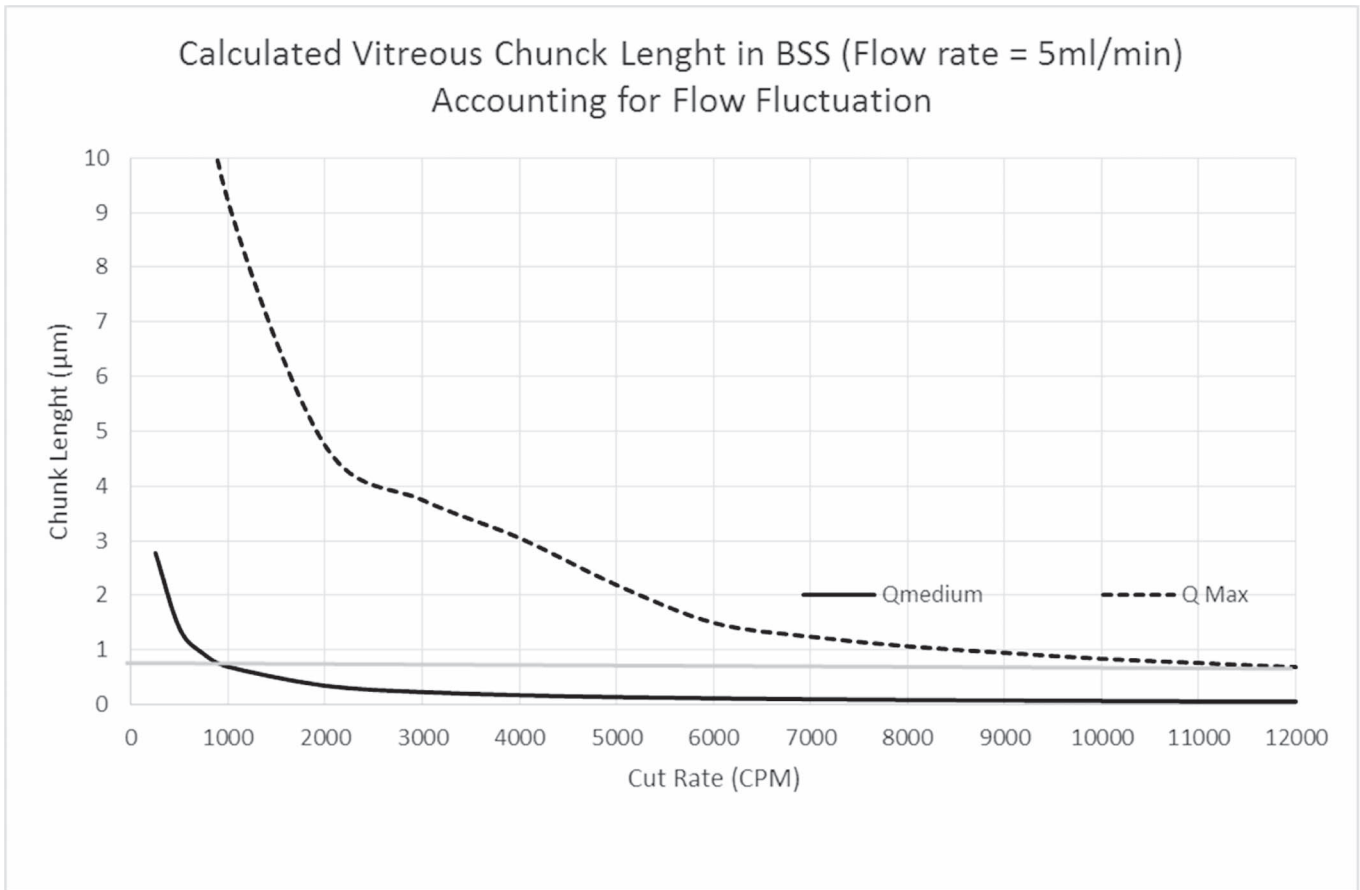

Figure 6. TVCL as a function of cut rate, calculated on actual flow rate, accounting for instantaneous flow fluctuation at average flow of 5 mL/min. Note that instantaneous flow fluctuation determines TVCL high variability, such that expected vitreous fragments length can be anywhere between 0 and 13 times the computed average value at any considered cut rate. Graphically, any point within the area under the Qmax curve is a valid TVCL value at each considered cut rate.

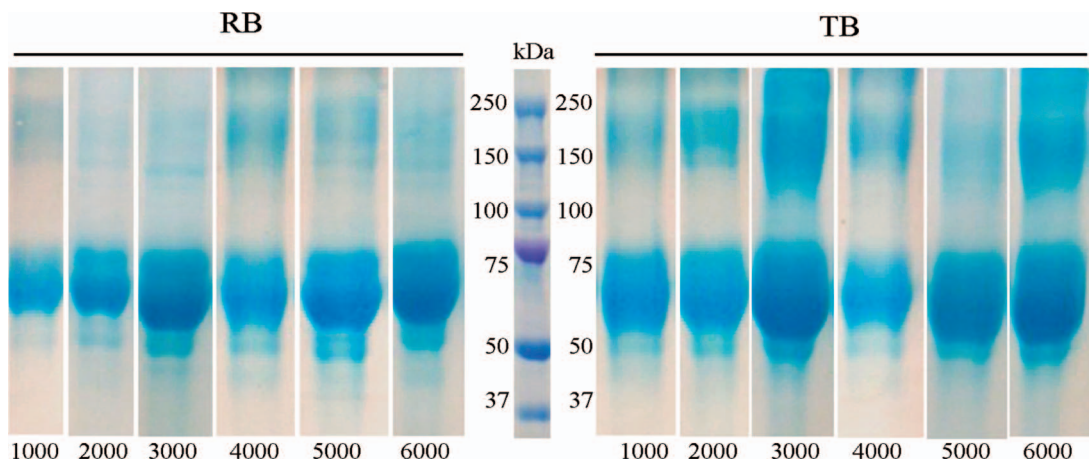

Figure 7. Electrophoretic analysis. Representative protein profile sketches specific for RB (A) and DEB (B) vitreous samples. Normalized samples (30 µg) were loaded for separation and bands were stained for visualization. For each panel, lanes are from left to right, soluble protein fractions from vitreous at respectively 1000, 2000, 3000, 4000, 5000, and 6000 CPM. Note that bands identifying protein size are comparable as cut rate increases from 1000 to 6000 CPM and similar regardless of blade design (compare [A] with [B]).

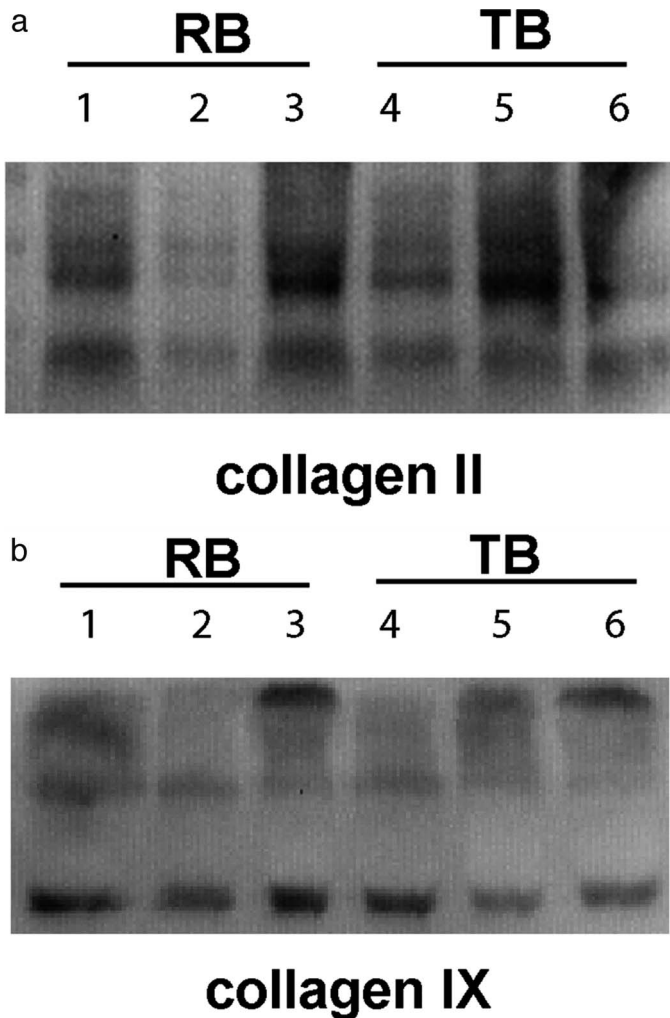

Figure 8. Western blot analysis. Representative DEB immunoblots specifically probed for collagen type II (a) and type IX (b). Lines 1 to 3 refer to RB and lines 4 to 6 to DEB at comparable cut rates: 1 and 4 are 1000 CPM; 2 and 5 are 3000 CPM; and 3 and 6 are 6000 CPM. Equal amounts of vitreous protein (30 μ g/lane) were loaded. No significant difference in protein weight can be detected for either blade as cut rate increases.

Table. Diameter Comparison of Available Vitreous Cutters; the Ratio of Surface, Fourth Power of Radius, Pressure, and Velocity are also Reported

	Diameter, mm	Surface Ratio (πr^2)	R^4 Ratio	Pressure Ratio	Velocity Ratio
20-G	0.89	1	1	1	1
23-G	0.64	0.52	0.26	3.7 \times	1.9 \times
25-G	0.51	0.33	0.11	8.9 \times	2.9 \times
27-G	0.41	0.22	0.04	21.6 \times	4.6 \times

Flow rate is fluid velocity times the surface and with the second power of radius (third column), while according to Hagen-Poiseuille law, pressure is inversely proportional to the fourth power of radius (fourth column). The fifth and sixth columns report, respectively, pressure and velocity change when caliper diminishes. Reference is a 20-G cutter: for example, a 25-G cutter needs 8.9 \times pressure and determines 2.9 \times fluid velocity increase in order to maintain the same average flow through its smaller lumen.

for viscous fluids or even non-Newtonian equations (especially when aspirated through small bores) may prove misleading.¹⁴

The rationale and hypothesis of this study is as follows: (1) if the cut rate increase creates smaller vitreous fragments and reduces vitreous viscosity, then HR must decrease, given the invariance of all other factors, and (2) if HR of the two blades working at the same cut rates differs, then the duty cycle-related port obstruction must be responsible for such difference.

HR in vitreous (Fig. 3) decreases between 0 and 1500 CPM, confirming previous observations³ but there is no further change from 2000 CPM to 12,000, therefore no changes in viscosity can be invoked. Of note, Megalhaes and colleagues³ did not test their hypothesis over 1500 CPM. Sharif-Kashani and colleagues¹⁵ described viscosity reduction of chopped compared with intact vitreous up to 2500 CPM, concluding that cut rate did not have any impact on viscosity. They also found that chopped vitreous compliance increased more than 50 times, showing increased elastic behavior.

It could be argued that preset flow of our peristaltic pump precluded flow increase while previous papers^{3,4} used a Venturi pump, imposing pressure and allowing flow as a function of viscosity. However, if viscosity indeed changed, HR (Fig. 3 and pressure in Fig. 4) would vary as a function of cut rate.

We interpret this result as follows: at 0 CPM HR is the highest regardless of blade design because uncut gel fibrils obstruct the port. The activating cut lowers HR at the same pace for the RB and DEB up to 1500 CPM when RB shows no further HR reduction while the DEB HR keeps falling up to 2000 CPM, then plateauing up to 12,000 CPM. The DEB outperforms the RB over 2000 CPM, offering significantly less HR

to produce the same flow, due to its constant 100% duty cycle.

Vitreous samples collected at increasing cut rates did not yield protein fragment bands of different sizes (Fig. 7), even when using immunoblotting for type II (Fig. 8a) and type IX (Fig. 8b) collagen, in agreement with Sharif-Kashani results.¹⁵ Neither did samples of the RB and DEB at the same cut rate. On the other hand, the theoretical vitreous fragment size calculated in Figure 5 and corrected as per flow fluctuations in Figure 6, shows that over 3000 CPM, expected vitreous fragment should be comparable to collagen fibers length ($0.3 \mu\text{m}^{16}$ circa).

One explanation for this is perhaps when aspiration attracts vitreous through the cutter port, the shear force exerted by blade motion disrupts the weaker hydrogen bonds between single collagen molecules instead of the much stronger covalent bonds between amino acids, producing smaller aggregates without severing the fibers themselves. When vitreous proteins (including collagen) are denatured for Western blot analysis, macroaggregates disrupt and no difference are noted.

Another cause could be the instantaneous flow fluctuations due to the so-called “plunger effect” that might produce such a high variability of collagen fragments per each given cut rate such that no significant difference could be detected.

BSS HR (Fig. 2) is also informative, being lowest at 0 CPM (Fig. 2), when HR is only generated by the viscous effect then equally rising between 0 and 1500 CPM for both blades, most likely due to the motion of the blade within the aspirating conduit, the so-called “plunger effect” that instantaneously drags fluid against pump-driven flow (see also Fig. 4). The RB and DEB behave identically between 0 and 3000 CPM, suggesting duty cycle affects HR very little up to this cut rate. Over 3000 CPM, RB HR steadily increases due to the progressively increasing port obstruction by the guillotine blade,¹⁷ whereas the DEB HR remains nearly unchanged up to 12,000 CPM.

Pressure graphs (Figs. 4a, 4b) further clarify this concept: as cut rate increases, RB requires a progressively higher pressure to generate the same flow while DEB does not.¹⁸ Interestingly, at 6000 CPM the RB requires comparable pressures to aspirate BSS or vitreous (Fig. 4a), despite a much higher viscosity of the latter, while the DEB allows a much greater difference (Fig. 4b). This is completely related to duty cycle and indicates that RB port obstruction at high cut rates is a very relevant

obstacle, even with low viscosity fluids such as BSS, and is the most important factor limiting flow rate.

In summary, DEB is significantly more efficient than RB, requiring less pressure to achieve the same flow, and alternatively, attaining a higher flow for a given preset vacuum when a Venturi pump is used, the two being conceptually equivalent.

In general, given a probe size and a flow rate, working at lower vacuums is preferable as far as it allows less perturbation and a smoother behavior in case of occasional port obstruction, or small solid fragment aspiration.

Our data does not support the hypothesis of viscosity reduction as a function of cut rate. Additionally, our measurements and analysis does not support the hypothesis that higher cut rates produce smaller fragments, thus allowing easier aspiration.

Increasing cut rate, on the other hand, is theoretically desirable in that faster reciprocation reduces retinal traction¹⁹ under the assumption that instantaneous flow is indeed constant. While there is no doubt that 100% duty cycle blades improve surgical efficiency, future efforts should aim at achieving a completely invariant flow for a safer and smoother vitrectomy.

Acknowledgments

Supported in part by the Ministry of Health and “Fondazione Roma” (Italy).

Giampiero Angelini, Carlo Malvasi, Alessandro Rossi, and Mario Morini are employees of Optikon 2000 Inc; DICAAR has a research agreement with Optikon 2000 Inc.; none of the other authors has any financial interest in the subject matter.

Disclosure: **T. Rossi**, None; **G. Querzoli**, Optikon 2000 (C); **G. Angelini**, Optikon 2000 (E); **C. Malvasi**, Optikon 2000 (E); **A. Rossi**, Optikon 2000 (E); **M. Morini**, Optikon 2000 (E); **G. Ripandelli**, None; **G. Esposito**, None; **A. Micera**, None; **N.M. Di Luca**, None

References

1. Sato T, Emi K, Bando H, Ikeda T. Faster recovery after 25-gauge microincision vitrectomy surgery than after 20-gauge vitrectomy in patients

- with proliferative diabetic retinopathy. *Clin Ophthalmol*. 2012;6:1925–1930.
2. Rossi T, Querzoli G, Angelini G, et al. Instantaneous flow rate of vitreous cutter probes. *Investigative Ophthalmol Vis Sci*. 2014;55:8289–8294.
 3. Rossi T, Querzoli G, Angelini G, et al. Fluid dynamics of vitrectomy probes. *Retina*. 2014;34:558–567.
 4. Magalhaes O, Chong L, DeBoer C, et al. Vitreous dynamics. Vitreous flow analysis in 20, 23, 25-gauge cutters. *Retina*. 2008;28:236–241.
 5. Ribeiro RM, Teixeira AG, Diniz B, et al. Performance analysis of ultrahigh-speed vitreous cutter system. *Retina*. 2013;33:928–932.
 6. Rossi T, Querzoli G, Malvasi C, Iossa M, Angelini G, Ripandelli G. A new vitreous cutter blade engineered for constant flow vitrectomy. *Retina*. 2014;3:1487–1491.
 7. Bishop PN, Holmes DF, Kadler KE, McLeod D, Bos KJ. Age-related changes on the surface of vitreous collagen fibrils. *Invest Ophthalmol Vis Sci*. 2004;45:1041–1046.
 8. Machemer R, Buettner H, Norton EW, Parel JM. Vitrectomy: a pars plana approach. *Trans Am Acad Ophthalmol Otolaryngol*. 1971;75:813–820.
 9. Machemer R. Reminiscences after 25 years of pars plana vitrectomy. *Am J Ophthalmol*. 1995;119:505–510.
 10. Hubschman JP, Gupta A, Bourla DH, Culjat M, Yu F, Schwartz SD. 20-, 23-, and 25-gauge vitreous cutters: performance and characteristics evaluation. *Retina*. 2008;28:249–257.
 11. Locke JC, Morton WR. Further studies of the viscosity of aspirated human vitreous fluid: with special reference to its use in retinal detachment surgery. *Trans Am Ophthalmol Soc* 1965;63:129–145.
 12. Lee B, Litt M, Buchsbauma G. Rheology of the vitreous body. Part I: viscoelasticity of human vitreous. *Biorheology*. 1992;29:521–533.
 13. Dugel P, Zhou J, Abulon DJK, Buboltz DC. Tissue attraction associated with 20-gauge, 23-gauge, and enhanced 25-gauge dual-pneumatic vitrectomy probes. *Retina*. 2012;32:1761–1766.
 14. Sharif-Kashani P, Hubschman J-P, Sassoon D, Pirouz Kavehpour H. Rheology of the vitreous gel: effects of macromolecule organization on the viscoelastic properties. *J Biomech*. 2011;44:419–423.
 15. Sharif-Kashani P, Nishida K, Kavehpour HD, Schwartz SD, Hubschman JP. Effect of cut rates on fluidic behaviour of chopped vitreous. *Retina*. 2013;33:166–169.
 16. Lodish H, Berk A, Zipursky SL, et al. Collagen: the fibrous proteins of the matrix. In: Editor(s), ed. *Molecular Cell Biology*. 4th edition. New York, NY: W. H. Freeman; 2000:574–580.
 17. Sato T, Kusaka S, Oshima Y, Fujikado T. Analyses of cutting and aspirating properties of vitreous cutters with high-speed camera. *Retina*. 2008;28:749–754.
 18. Hubschman JP, Bourges JL, Tsui I, Reddy S, Yu F, Schwartz SD. Effect of cutting phases on flow rate in 20-, 23-, and 25-gauge vitreous cutters. *Retina*. 2009;29:1289–1293.
 19. Teixeira A, Chong L, Matsuoka N, et al. An experimental protocol of the model to quantify traction applied to the retina by vitreous cutters. *Invest Ophthalmol Vis Sci*. 2010;51:4181–4186.